



CIF
COMPOSITES INC.

4-Series 22.5 deg. Headwall Structure

CIF Product Code: 4XPhdLP
Canadian Patent # 92138 - US Patent # 447,544
(s/s insert bolts washers and caulk supplied)

PRO-ECO-LITE™

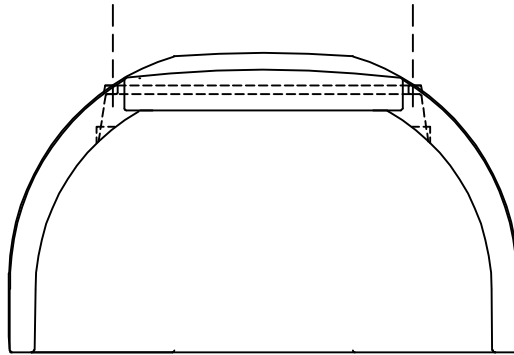

4XPhdLP

IMPORTANT
This design drawing
is the property of
CIF COMPOSITES INC.
and is distributed for reference
purposes only.

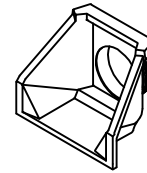

Type:
Weir Model



Type:
Standard -
45 Degree

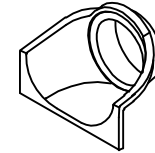

Type:
Low Profile -
22.5 Degree

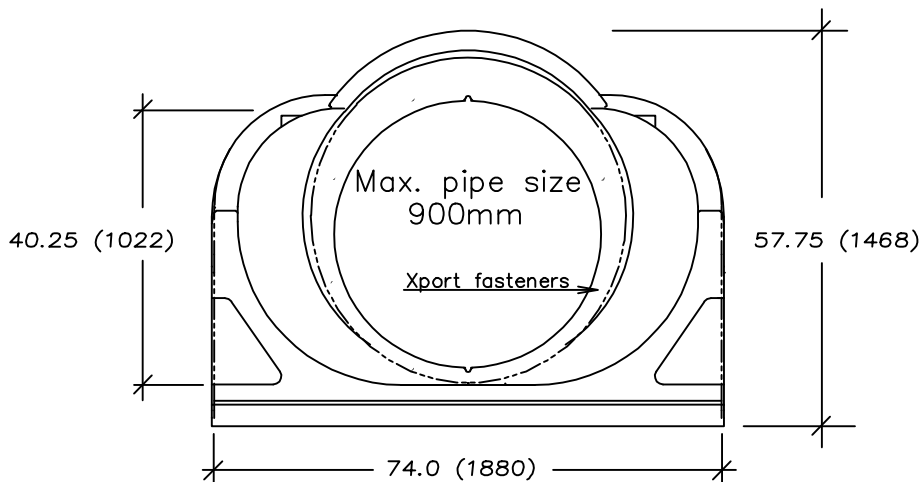

4 Series Xport Headwall Low Profile

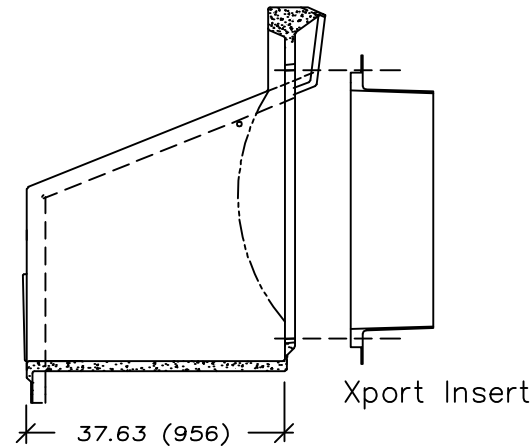

Xport Insert